



ALLBLACK

INTENSE SHADE

NASH
STONE GROUP

L'ESSENZA ORIGINARIA DELLA PIETRA.

—
THE ORIGINAL ESSENCE OF STONE.

ALLBLACK nasce dalla fusione di tre graniti originari di India e Svizzera: **Phyllite Ocean Black, Marine Black Soapstone e Vals Stone**. La creatività NovaBell incontra la contaminazione per creare un nuovo gres che esalta le caratteristiche della materia d'ispirazione.

ALLBLACK is a fusion of three granites sourced from India and Switzerland: Phyllite Ocean Black, Marine Black Soapstone and Vals Stone. NovaBell creativity adopts a cross-contamination approach, to give us a new stoneware where the inspiration material's characteristics are superbly highlighted.

L'ESSENCE ORIGINELLE DE LA PIERRE.
ALLBLACK est le fruit de la fusion entre trois granits originaires de l'Inde et de la Suisse : **Phyllite Ocean Black, Marine Black Soapstone et Vals Stone.**

La créativité NovaBell mise sur la fusion des styles pour créer un nouveau grès qui exalte les caractéristiques de la matière d'inspiration.

DAS UREIGENE WESEN VON STEIN.
ALLBLACK beruht auf der Fusion von drei Granitgesteinen aus Indien und der Schweiz: **Phyllite Ocean Black, Marine Black Soapstone und Vals Stone.**

Die Experimentierfreude von NovaBell spielt in einem neuen Feinsteinzeug mit ungewohnten Mixturen, die den Besonderheiten der Materialvorlage Geltung verleihen.

CINQUE SFUMATURE DI STILE.

FIVE STYLISH
COLOUR SHADES.



La superficie materica declinata in cinque tonalità, presenta una stonalizzazione armoniosa, impreziosita da fiammature di Quarzo Bianco. ALLBLACK trasferisce all'architettura contemporanea un carattere sobrio ed elegante.

The tactile surface, offered in five colours, features attractive variation in shade and exquisite White Quartz flaming. ALLBLACK bestows a tasteful, elegant character on contemporary architecture.

CINQ NUANCES DE STYLE. Déclinée en cinq tonalités, la surface à effet de matière présente une harmonieuse variation de nuances, embellie par la finition flammée du quartz blanc. ALLBLACK donne à l'architecture contemporaine un caractère sobre et élégant.

FÜNF STILVOLLE NUANCEN. Die materialbetonte Oberfläche in fünf Farbstellungen besticht mit harmonischen Farbverläufen und kostbar schimmernden Flammungen aus Weißquarz. ALLBLACK bringt in die moderne Architektur eine strenge Eleganz ein.

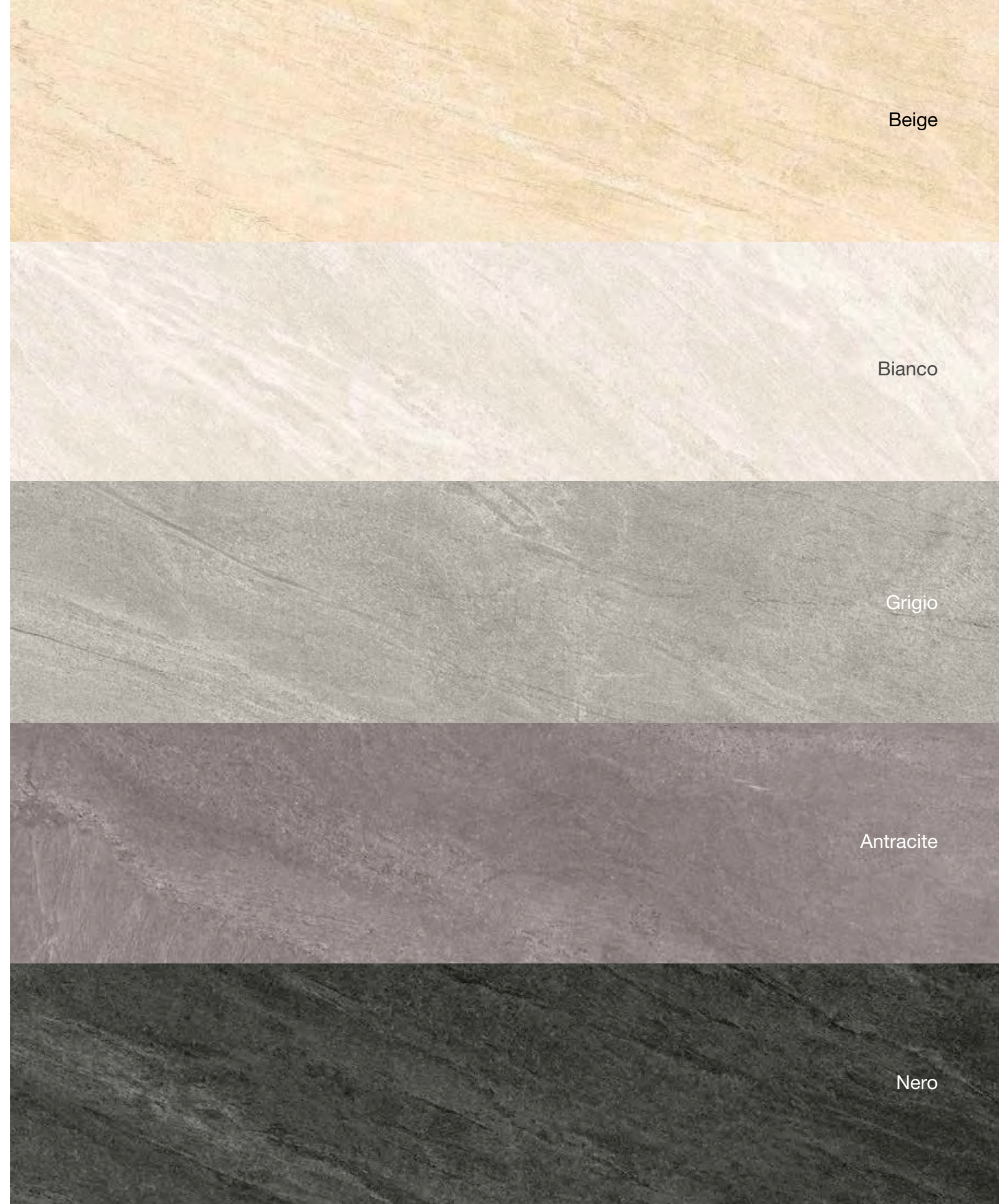

Beige

Bianco

Grigio

Antracite

Nero

FORME E MATERIA.

SHAPES AND MATTER.

I moduli ALLBLACK, fondi e decorazioni, mettono in luce i movimenti grafici delle pietre di riferimento. Le sfumature direzionali disegnano le grandi superfici 60x120 cm e contemporaneamente vivacizzano i formati più contenuti.

The ALLBLACK modules, plain tiles and decorations showcase the graphic variegation of the reference stones. The directional shade variations pattern the large 60x120 cm surfaces and simultaneously give vibrancy to the smaller sizes.

FORMES ET MATIÈRE.
Les modules ALLBLACK, fonds et décorations mettent en valeur les mouvements graphiques des pierres de référence. Les dégradés directionnels dessinent l'aspect des grandes surfaces 60x120 cm, tout en animant les formats plus petits.

FORMEN UND MATERIAL.
Die Module von ALLBLACK, Grundfliesen und Dekorationen, bringen die Linien und Strukturen ihrer Gesteinsvorlagen zur Geltung. Die in eine Richtung orientierten Farbverläufe gestalten die Großformate 60x120 cm und beleben zugleich die kleineren Formate.

20 mm

OUT WALK
20
Porcelain
slabs

NEW SIZE



60x120

23^{5/8}"x47^{1/4}"



60x90

23^{5/8}"x35^{7/16}"

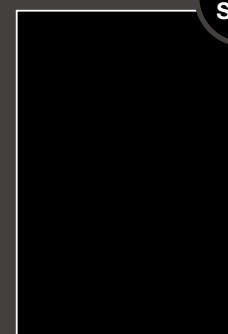

60x90x2

23^{5/8}"x35^{7/16}"x3/4"

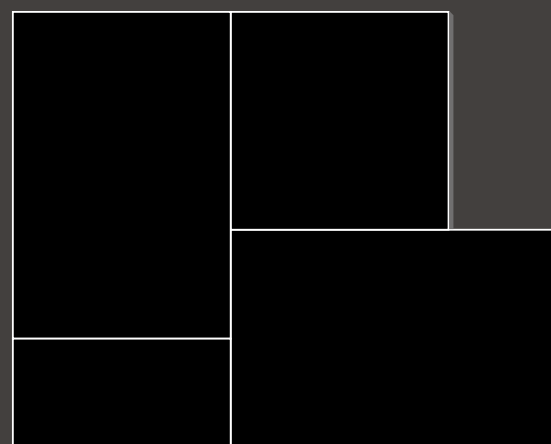

MULTISIZE



60x60

23^{5/8}"x23^{5/8}"



30x60

11^{13/16}"x23^{5/8}"

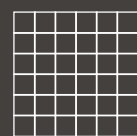

Mosaico
30x30

11^{13/16}"x11^{13/16}"

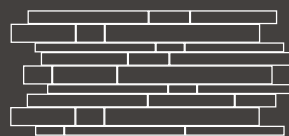

Mattoncino
30x60

11^{13/16}"x23^{5/8}"



Losanga
19,5x58,5

7^{7/16}"x23^{5/8}"





Ideale per ambienti pubblici, ma perfetto anche per ambienti residenziali, Losanga nasce dall'intreccio di quattro nuance.

Il gioco di precise geometrie crea un effetto ottico tridimensionale di grande impatto visivo.

Ideal for public locations but also perfect for small residential interiors, Losanga is founded on the interweaving of four shades.

The interplay of precise geometric forms creates a three-dimensional optical effect of striking visual impact.

Indiqué dans les lieux publics, et parfait dans les cadres résidentiels, Losanga mêle quatre nuances. Le jeu de formes précises met en scène un effet optique tridimensionnel de grand impact.

Losanga, ideal für öffentliche wie für private Bereiche, beruht auf der Fusion von vier Farbnuancen. Das Zusammenspiel verschiedener geometrischer Motive erzeugt eine beeindruckende plastische Wirkung.

**NERO
BIANCO**

+ LOSANGA

WALL: Bianco Rettificato 60x90 - 23^{5/8}x35^{7/16} / Nero Rettificato 60x90 - 23^{5/8}x35^{7/16}
FLOOR: Losanga Rettificato 19,5x58,5 - 7^{11/16}x23^{11/16}



ANTRACITE

WALL IN/OUT: Mattoncino Grigio 30x60 - 11^{13/16}x23^{5/8}
FLOOR IN/OUT: Antracite Rettificato 60x90 - 23^{5/8}x35^{7/16} / Antracite 20 MM Rettificato 60x90 - 23^{5/8}x35^{7/16}

VERY SPECIAL TRIMS.

Tutti i pezzi speciali NovaBell sono elementi progettati e pensati per modellarsi con estrema precisione a ogni contesto.

All NovaBell special trims are elements designed and produced to fit seamlessly and with extreme precision in any given setting.

Toutes les pièces spéciales NovaBell sont des éléments imaginés et conçus pour s'adapter à chaque espace avec une précision extrême.

Alle Formteile von NovaBell wurden gezeichnet und entwickelt, um sich mit äußerster Präzision in jeden Kontext einzufügen.

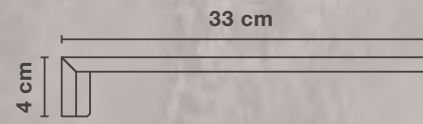
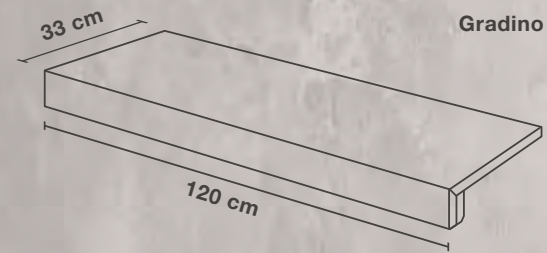

Igiene, comfort e praticità sono assicurati dalla qualità tecnica di ALLBLACK. Nei pavimenti e nei rivestimenti coordinati, nell'estrema cura dei dettagli e nella ricchezza dei complementi sono custodite la ricerca e la tecnologia firmate NovaBell.

The technical qualities of ALLBLACK ensure hygiene, comfort and convenience. The floor tiles and matching wall coverings, the extreme attention to details and the wealth of matching items all embody NovaBell's superlative research and technology.



La qualité technique d'ALLBLACK garantit hygiène, confort et fonctionnalité. Les revêtements de sol et mur coordonnés, le soin du détail et la profusion des accessoires expriment la recherche et la technologie signées NovaBell.

Für Hygiene, Komfort und Zweckmäßigkeit bürgen die Leistungsmerkmale von ALLBLACK. Aufeinander abgestimmte Boden- und Wandfliesen, liebevoll ausgearbeitete Details und vielfältige Zubehörelemente beruhen auf der Forschung und Technologie von NovaBell.

**NEW
SIZE**

60x90

23^{5/8}x35^{7/16}

BEIGE
GRIGIO

WALL IN: Beige Rettificato 60x120 - 23^{5/8}x47^{1/4}
WALL IN: Grigio Rettificato 60x120 - 23^{5/8}x47^{1/4} / Grigio Rettificato 60x90 - 23^{5/8}x35^{7/16} / Grigio Rettificato 60x60 - 23^{5/8}x23^{5/8}
WALL OUT: BRICKUP Ocean Ardesia 16x40 - 6^{5/16}x15^{3/4}
FLOOR OUT: Grigio 20 MM Rettificato 60x90 - 23^{5/8}x35^{7/16}

OUT WALK 20
Porcelain
slabs



**NEW
SIZE**

60x90x2

23^{5/8}x35^{7/16}x3/4"

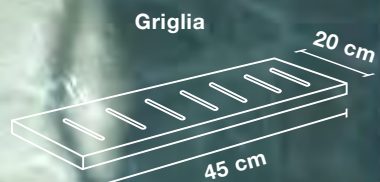

Una gamma completa di accessori e pezzi speciali consente la creazione di spazi da vivere in assoluta sicurezza.

A complete range of accessories and special trims enables the creation of completely safe living spaces.

La gamme complète d'accessoires et de pièces spéciales permet de créer des espaces à vivre en toute sécurité.

Ein umfassendes Sortiment an Zubehörelementen und Formteilen sorgt für das erforderliche Niveau von Sicherheit.



ARMONIE INEDITE.

ALLBLACK veste gli spazi del vivere quotidiano, dentro e fuori casa in un total look raffinato e coerente.

ORIGINAL HARMONIES.

ALLBLACK covers the spaces of daily life, inside and outside the home, in a refined, seamless total look.

HARMONIES INÉDITES.
ALLBLACK habille les lieux de la vie quotidienne, à l'intérieur et à l'extérieur de la maison dans un total look élégant et cohérent.

NEUE HARMONIEN.
ALLBLACK gestaltet die Alltagswelt, die Innen- und Außenbereiche des Zuhauses in einem wertigen, stringenten Total-Look.

OUT
WALK

20
Porcelain
slabs



BEIGE



WALL: Beige Rettificato 60x120 - 23^{5/8}x35^{7/16}
FLOOR OUT: Beige 20 MM Rettificato 60x90 - 23^{5/8}x35^{7/16}
FLOOR IN: Beige Rettificato 60x90 - 23^{5/8}x35^{7/16}

MULTIFORMATO 1 & 2

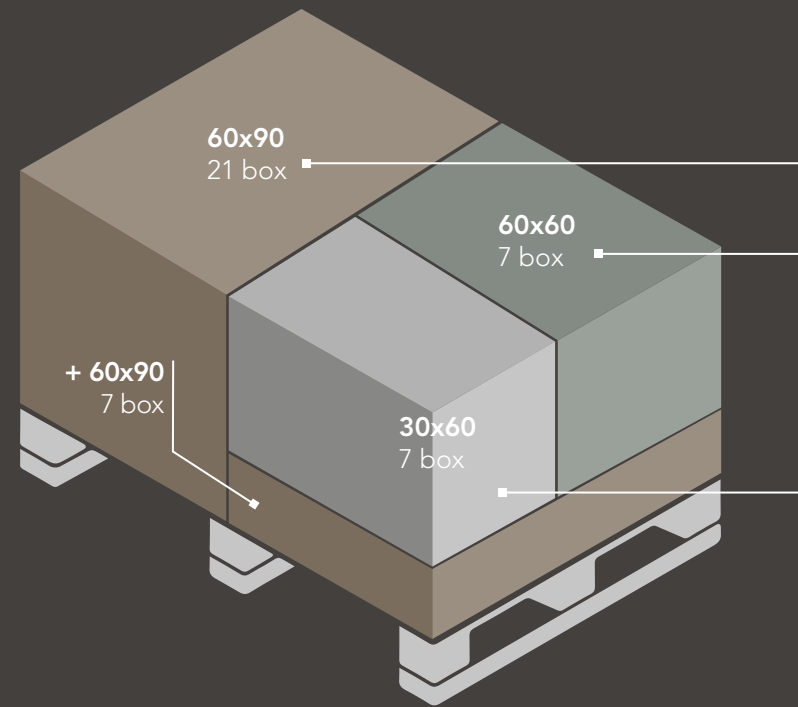

60x90 23 ^{5/8} x35 ^{7/16} 1 pcs/box	60x60 23 ^{5/8} x23 ^{5/8} 2 pcs/box
60x90 23 ^{5/8} x35 ^{7/16} 1 pcs/box	30x60 11 ^{13/16} x23 ^{5/8} 2 pcs/box

60x90 → 66,67%
 60x60 → 22,22%
 30x60 → 11,11%

NovaBell si impegna costantemente nel servizio e assistenza al cliente. Per gli articoli MULTIFORMATO, le proporzioni di posa, sono state calcolate e organizzate in pallet pronti all'uso. Questo servizio regala velocità di installazione e risparmio di tempo.

NovaBell provides constant customer service and assistance. For MULTIPLE-SIZE modules, the installation proportions are calculated and organized in ready-to-use pallets. This service speeds up the installation process and saves time.

NovaBell est constamment engagée au service et l'assistance de la clientèle. Pour les articles MULTIFORMAT, les proportions de pose ont été calculées et organisées en palettes prêtes à l'emploi. Ce service permet rapidité d'installation et gain de temps.

NovaBell steht konstant im Dienst des Kunden und bietet in diesem Sinn entsprechende Leistungen. Hinsichtlich der MEHRFORMATIGEN Artikel werden die Verlegeproportionen passend berechnet und auf verarbeitungsfertigen Paletten organisiert. Dieser Service gewährleistet eine rasche Verlegung und Zeitersparnis.



GRIGIO



FLOOR IN/OUT: MULTIFORMATO Grigio Rettificato
 Gradino Elle Rettificato 30x90x5 - 11^{13/16}x35^{7/16}x2^{1/8} / Griglia Angolo DX e SX Rettificato 20x45 - 7^{7/8}x17^{11/16} / Griglia Rettificato 20x45 - 7^{7/8}x17^{11/16}



I colori e i pattern grafici **BRICKUP** sono stati progettati per ottenere una perfetta armonia estetica con tutte le pavimentazioni **NovaBell**. Questa importante caratteristica consente la risoluzione di tutte le esigenze tecniche e progettuali, tipiche degli spazi outdoor.

The colours and graphic patterning **BRICKUP** have been designed to combine to perfection with all the **NovaBell** floor coverings. Thanks to this important characteristic, all the technical and design needs typical of outdoor locations can be met to the full.

Les couleurs et les fantaisies graphiques **BRICKUP** ont été créées pour obtenir une parfaite harmonie esthétique avec tous les revêtements de sol **NovaBell**. Cette importante caractéristique permet de répondre à toutes les exigences techniques et conceptuelles, typiques des applications extérieures.

Die Farben und strukturellen **BRICKUP** Muster wurden so konzipiert, dass eine perfekte Harmonie mit allen Materialoptiken der Bodenbeläge von **NovaBell** erzielt wird. Diese wichtige Eigenschaft ermöglicht es, allen technischen und planerischen Anforderungen, die bei der Gestaltung von Außenbereichen entstehen, gerecht zu werden.



GRIGIO

+



WALL: Ocean Beige 16x40 - 6^{5/16}x15^{3/4}
 FLOOR: ALLBLACK Grigio 20 MM Rettificato 60x90 - 23^{5/8}x35^{7/16} / Gradino Elle Rettificato 30x90x5 - 11^{13/16}x35^{7/16}x2^{1/2}
 Griglia Angolo DX e SX Rettificato 20x45 - 7^{7/8}x17^{11/16} / Griglia Rettificato 20x45 - 7^{7/8}x17^{11/16}

ALLBLACK GRIGIO

INTENSE SHADE

9.5 mm cm. 60x120 inch. 23⁵/₈x47¹/₄ cm. 60x90 inch. 23⁵/₈x35⁷/₁₆ cm. 60x60 inch. 23⁵/₈x23⁵/₈ cm. 30x60 inch. 11¹³/₁₆x23⁵/₈ 20 mm cm. 60x90 inch. 23⁵/₈x35⁷/₁₆



60x120 - 23⁵/₈x47¹/₄ **02**
ALK 12RT Grigio Rettificato **1075**



30x60 - 11¹³/₁₆x23⁵/₈ **07**
ALK 16RT Grigio Rettificato **1035**



60x60 - 23⁵/₈x23⁵/₈ **03**
ALK 10RT Grigio Rettificato **1055**



60x90 - 23⁵/₈x35⁷/₁₆ **02**
ALK 19RT Grigio Rettificato **1070**

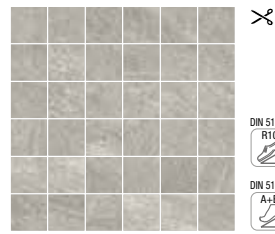

30x30 - 11¹³/₁₆x11¹³/₁₆ **10**
ALK 115N Mos. 5x5 Grigio **3115**

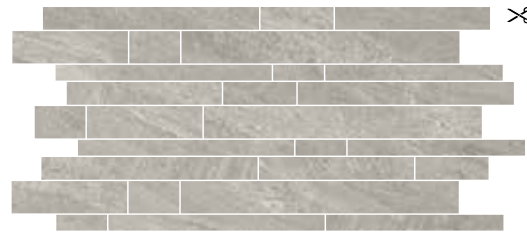

30x60 - 11¹³/₁₆x23⁵/₈ **04**
ALK 117N Mattoncino Grigio **3120**

ALLBLACK ANTRACITE

INTENSE SHADE

TECHNICAL	DIN 51130	DIN 51097	BCR	ANSI DCOF	Deep Abrasion Resistance	MOHS	Recommended Use	Resistance to Staining	ANSI A 137.1
NATURAL	R10	A+B	DRY > 0.40 WET > 0.40	WET ≥ 0.42	< 175 mm ³	≥ 5	4	5	V3



60x120 - 23⁵/₈x47¹/₄ **02**
ALK 22RT Antracite Rettificato **1075**



30x60 - 11¹³/₁₆x23⁵/₈ **07**
ALK 26RT Antracite Rettificato **1035**



60x60 - 23⁵/₈x23⁵/₈ **03**
ALK 20RT Antracite Rettificato **1055**



60x90 - 23⁵/₈x35⁷/₁₆ **02**
ALK 29RT Antracite Rettificato **1070**

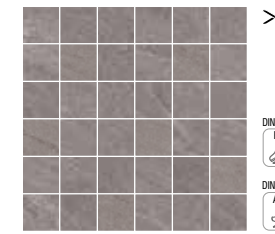

30x30 - 11¹³/₁₆x11¹³/₁₆ **10**
ALK 225N Mos. 5x5 Antracite **3115**

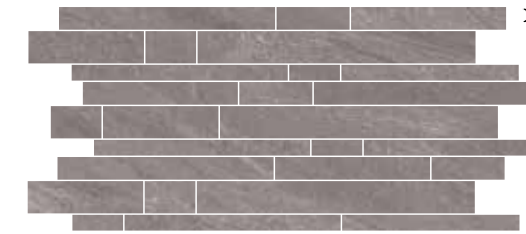

30x60 - 11¹³/₁₆x23⁵/₈ **04**
ALK 227N Mattoncino Antracite **3120**

LA SCALA DI CASA TUA.

YOUR STAIRCASE. / DIE TREPPE IN IHREM ZUHAUSE. / L'ESCALIER DE VOTRE MAISON.

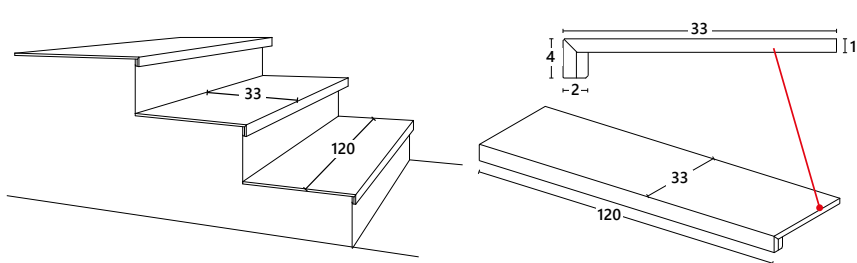

9.5 MM	Battiscopa 7x60	Gradino Elle Rettificato 33x1120x4	Angolo DX Rettificato 33x120x4	Angolo SX Rettificato 33x120x4
	15 230	01 670	01 676	01 676
	ALK B10K	ALK G11K	ALK G12K	ALK G15K

* 6 SETTIMANE DI CONSEGNA / DELIVERY WEEKS / SECHS WOCHEN LIEFERZEIT / SEMAINES DE LIVRAISON



19.5x58.5 - 7¹¹/₁₆x23¹/₁₆ **06**
ALK 1289 Losanga Rettificato **1160**

9.5 MM	Battiscopa 7x60	Gradino Elle Rettificato 33x1120x4	Angolo DX Rettificato 33x120x4	Angolo SX Rettificato 33x120x4
	15 230	01 670	01 676	01 676
	ALK B20K	ALK G21K	ALK G22K	ALK G25K

* 6 SETTIMANE DI CONSEGNA / DELIVERY WEEKS / SECHS WOCHEN LIEFERZEIT / SEMAINES DE LIVRAISON

ALLBLACK BIANCO

INTENSE SHADE

9.5 mm cm. 60x120 inch. 23 5/8x47 1/4 | cm. 60x90 inch. 23 5/8x35 7/16 | cm. 60x60 inch. 23 5/8x23 5/8 | cm. 30x60 inch. 11 13/16x23 5/8 | 20 mm cm. 60x90 inch. 23 5/8x35 7/16

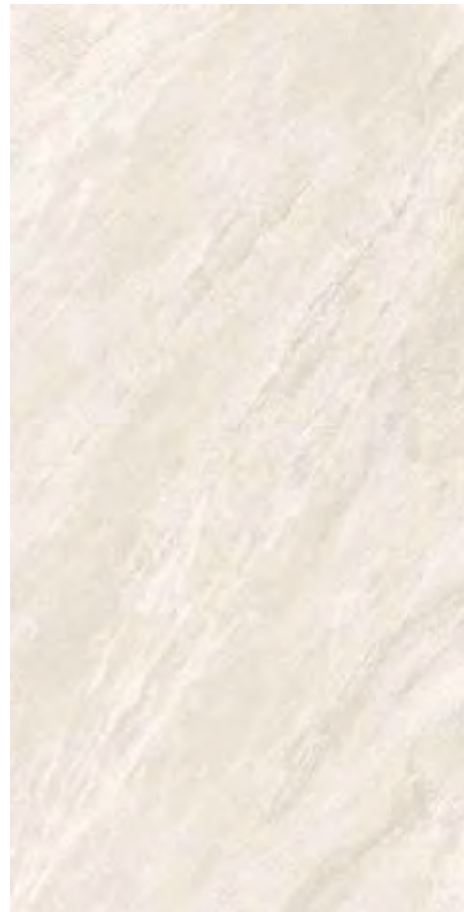

60x120 - 23 5/8x47 1/4
ALK 82RT Bianco Rettificato



30x60 - 11 13/16x23 5/8
ALK 86RT Bianco Rettificato



60x60 - 23 5/8x23 5/8
ALK 80RT Bianco Rettificato



60x90 - 23 5/8x35 7/16
ALK 89RT Bianco Rettificato

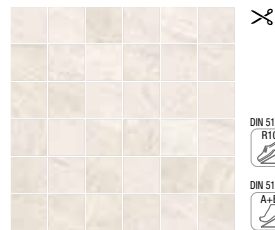

30x30 - 11 13/16x11 13/16
ALK 885N Mos. 5x5 Bianco



30x60 - 11 13/16x23 5/8
ALK 887N Mattoncino Bianco

ALLBLACK NERO

INTENSE SHADE

TECHNICAL	DIN 51130	DIN 51097	BCR	ANSI DCOF	Deep Abrasion Resistance	MOHS	Recommended Use	Resistance to Staining	ANSI A 137.1
N NATURAL	R10	A+B	DRY > 0.40 WET > 0.40	WET ≥ 0.42	< 175 mm ³	≥ 5	4	5	V3



60x120 - 23 5/8x47 1/4
ALK 92RT Nero Rettificato



30x60 - 11 13/16x23 5/8
ALK 96RT Nero Rettificato



60x60 - 23 5/8x23 5/8
ALK 90RT Nero Rettificato



60x90 - 23 5/8x35 7/16
ALK 99RT Nero Rettificato

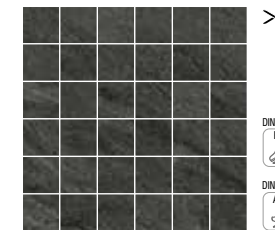

30x30 - 11 13/16x11 13/16
ALK 995N Mos. 5x5 Nero

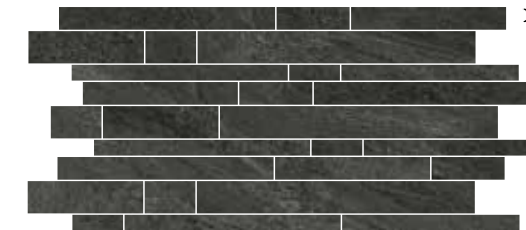

30x60 - 11 13/16x23 5/8
ALK 997N Mattoncino Nero

LA SCALA DI CASA TUA.

YOUR STAIRCASE. / DIE TREPPE IN IHREM ZUHAUSE. / L'ESCALIER DE VOTRE MAISON.

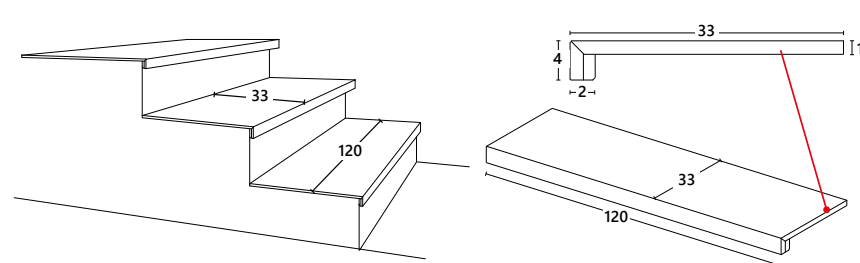

9.5 MM	Battiscopa 7x60	Gradino Elle Rettificato 33x1120x4	Angolo DX Rettificato 33x120x4	Angolo SX Rettificato 33x120x4
	15 230	01 670	01 676	01 676
	ALK B80K	ALK G81K	ALK G82K	ALK G85K

* 6 SETTIMANE DI CONSEGNA / DELIVERY WEEKS / SECHS WOCHEN LIEFERZEIT / SEMAINES DE LIVRAISON



19.5x58.5 - 7 11/16x23 1/16
ALK 1289 Losanga Rettificato

9.5 MM	Battiscopa 7x60	Gradino Elle Rettificato 33x1120x4	Angolo DX Rettificato 33x120x4	Angolo SX Rettificato 33x120x4
	15 230	01 670	01 676	01 676
	ALK B90K	ALK G91K	ALK G92K	ALK G95K

* 6 SETTIMANE DI CONSEGNA / DELIVERY WEEKS / SECHS WOCHEN LIEFERZEIT / SEMAINES DE LIVRAISON

ALLBLACK BEIGE

INTENSE SHADE

 **cm. 60x120**
 inch. 23⁵/₈x47¹/₄



cm. 60x90
 inch. 23⁵/₈x35⁷/₁₆

cm. 60x60
 inch. 23⁵/₈x23⁵/₈

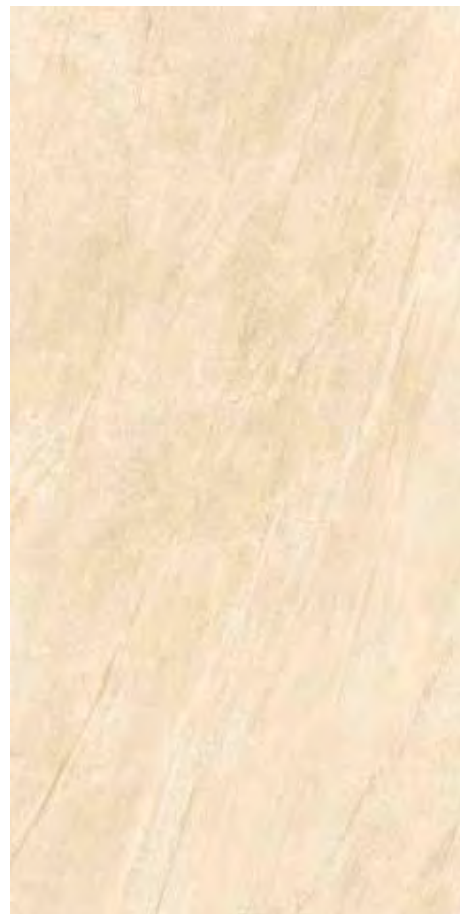

cm. 30x60
 inch. 11¹³/₁₆x23⁵/₈

 **cm. 60x90**
 inch. 23⁵/₈x35⁷/₁₆





60x120 - 23⁵/₈x47¹/₄
ALK 42RT Beige Rettificato  



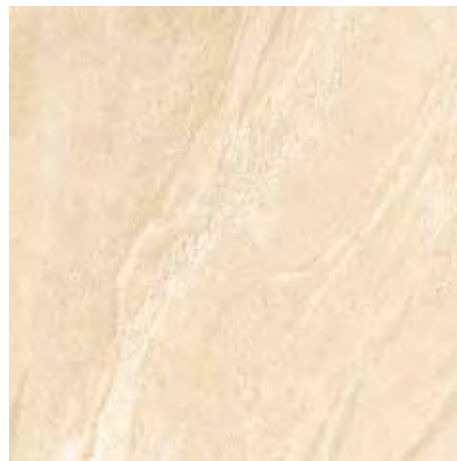

30x60 - 11¹³/₁₆x23⁵/₈
ALK 46RT Beige Rettificato  



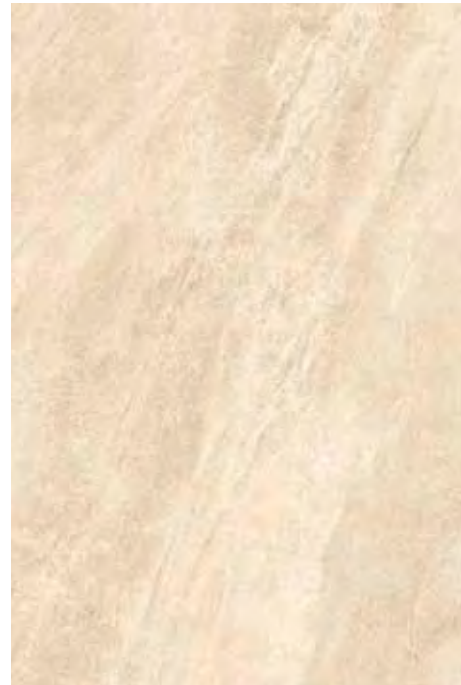

60x60 - 23⁵/₈x23⁵/₈
ALK 40RT Beige Rettificato  

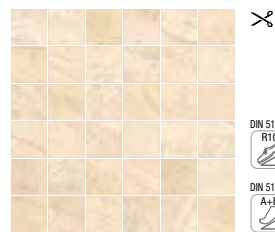

60x90 - 23⁵/₈x35⁷/₁₆
ALK 49RT Beige Rettificato  



30x30 - 11¹³/₁₆x11¹³/₁₆
ALK 445N Mos. 5x5 Beige  



30x60 - 11¹³/₁₆x23⁵/₈
ALK 447N Mattoncino Beige  

LAYING SCHEME MULTISIZE

9,5 MM

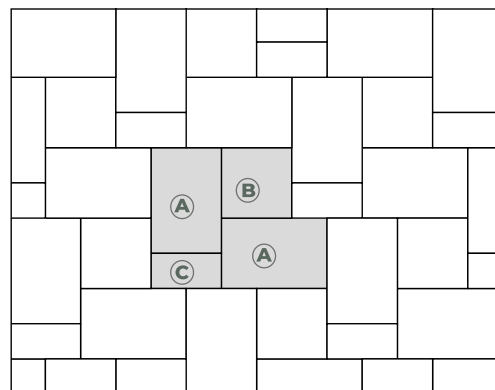

A 60x90 = 66,67%

B 60x60 = 22,22%

C 30x60 = 11,11%

9,5 MM

			
Battiscopa 7x60	Gradino Elle Rettificato 33x1120x4	Angolo DX Rettificato 33x120x4	Angolo SX Rettificato 33x120x4
 	 	 	 
ALK B40K	ALK G41K	ALK G42K	ALK G45K

6 SETTIMANE DI CONSEGNA / DELIVERY WEEKS /
 SECHS WOCHEN LIEFERZEIT / SEMAINES DE LIVRAISON



ALLBLACK

INTENSE SHADE

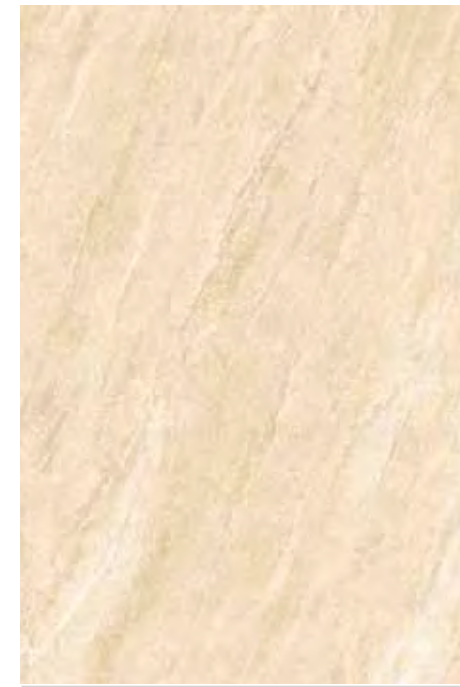

 **cm. 60x90**
 inch. 23⁵/₈x35⁷/₁₆

TECHNICAL	DIN 51130	DIN 51097	BCR	ANSI DCOF	Deep Abrasion Resistance	MOHS	Recommended Use	Resistance to Staining	ANSI A 137.1
OUT WALK	20 MM	R11	A+B+C	DRY > 0.40 WET > 0.40	< 130 mm ³	≥ 8	5	5	 V3



60x90 - 23⁵/₈x35⁷/₁₆
ALK 469R Beige 20 MM Rettificato  





60x90 - 23⁵/₈x35⁷/₁₆
ALK 169R Grigio 20 MM Rettificato  



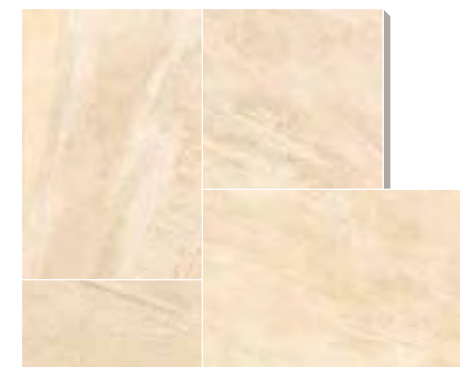

60x90 - 23⁵/₈x35⁷/₁₆
ALK 269R Antracite 20 MM Rettificato  



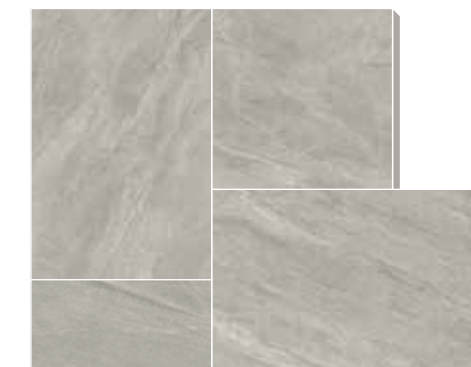

MULTIFORMATO
ALK M433 Modulo 3 Formati Beige 20 MM Rett.  



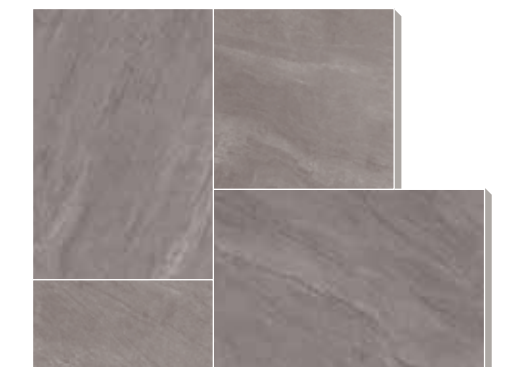















MULTIFORMATO
ALK M133 Modulo 3 Formati Grigio 20 MM Rett.  



MULTIFORMATO
ALK M233 Modulo 3 Formati Antracite 20 MM Rett.  

PEZZI SPECIALI ON DEMAND 20MM*

Special coordinated pieces. Zusammenstellbare Formteile. Pièces spéciales coordonnées.

					
Toro Gradino 30x90	Bordo Rett. Antiderapant 30x90	Bordo Angolo SX / DX Rett. 30x90	Griglia Rettificata 20x45	Griglia Angolo SX / DX Rett. 20x45	
 	 	 	 	 	
BEIGE	ALK G43K	ALK W41K	ALK W42K	ALK W45K	ALK W46K
GRIGIO	ALK G13K	ALK W11K	ALK W12K	ALK W15K	ALK W16K
ANTRACITE	ALK G23K	ALK W21K	ALK W22K	ALK W25K	ALK W26K

6 SETTIMANE DI CONSEGNA / DELIVERY WEEKS /
 SECHS WOCHEN LIEFERZEIT / SEMAINES DE LIVRAISON

The International reference standards: ANSI - ASTM **NATURALE**

	Characteristics and Test methods	Requirements ANSI A 137.1	Our general values
	Determination of water absorption - (ASTM C 373)	Average value $E_b \leq 0,5\%$	Average value $\leq 0,06\%$
	Classification	Definition § 3.0	Porcelain tiles
			Physical properties
	Breaking strength - (ASTM C 648)	Average ≥ 250 lbf (1.11 kN) Individual ≥ 225 lbf (1.00 kN)	Complies
	Visible abrasion - (ASTM C 1027)	As reported	Class 0 - 5
	Recommended use	Novabell criterion (see Annex N - ISO 13006 / EN 14411)	Class 4
	Thermal shock resistance - (ASTM C 428)	Pass	Complies
	Crazing resistance - (ASTM C 424)	Pass	Complies
	Resistance to freeze/thaw cycling - (ASTM C 1026)	As reported	Resistant
	Bond strength - (ASTM C 482)	≥ 50 psi (0.34 MPa)	> 1 MPa
	Color Uniformity - (ASTM C 609 and ANSI A 137.1 Section 9.3) ⁽¹⁾	V0 - 3 Juds	See the specific section
	Mohs hardness scale - (ex EN 101 / BS 6431-13)	-	≥ 5
			Chemical properties
	Chemical resistance - (ASTM C 650)	As reported	Resistant
	Stain resistance - (ASTM C 1378)	As reported	Resistant
			Dimensions - Calibrated tiles
	Dimensions - (ASTM C 499) - (ASTM C 485) - (ASTM C 502)	See ANSI A 137.1 - Tab. 10	Complies
			Dimensions - Rectified tiles
	Dimensions - (ASTM C 499) - (ASTM C 485) - (ASTM C 502)	See ANSI A 137.1 - Tab. 10	Complies
			Slipperiness
	DCOF Resistance (ANSI A 137.1 Section 9.6)	$\geq 0,42$ ⁽¹⁾	DCOF $\geq 0,42$

(1) For level interior spaces expected to be walked upon when wet (2) For V0 tiles only



**ALL BLACK
NATURALE**

 Utilizzare il **QR CODE** per scaricare le schede tecniche

 Use the **QR CODE** to download data sheets



**ALL BLACK
20MM**

 Veuillez utiliser le **QR CODE** pour télécharger les fiches techniques

 **QR CODE** benutzen um die technische datenblätter runter zu laden

OUT WALK	Bending Strength EN 13396	Water Absorption	DIN 51130	DIN 51097	BS 7976 Pendulum Tester Average Values	MOHS	Modulus of Rupture	Breaking Strength (for square slabs)	Compressive Strength
TECHNICAL DATA 20 MM	$\geq U11$ (for square slabs)	$\leq 0,03\%$	R11	A+B+C	wet ≥ 50 dry ≥ 55	≥ 8	≥ 50 N/mm ²	≥ 12.000 N	≥ 200 N/mm ²
Resistance to Staining	Resistance to household chemicals and swimming pool salts	Frost Resistance	Thermal Shock	Color Resistance UV Light		Reaction to Fire	≥ 500 kg/cm ²	≥ 1.200 kg	≥ 2.000 kg/cm ²
5	A	Complies	Resistant	Resistant	A1FL	$\geq 7,500$ psi	$\geq 2,700$ lbs	$\geq 29,000$ psi	

The International reference standards: ANSI - ASTM **NATURALE**

	Characteristics and Test methods	Requirements EN 14411 ⁽¹⁾ - G / ISO 13006 ⁽²⁾ - G	Our general values
	Determination of water absorption - (ISO 10545-3)	Average value $E_b \leq 0,5\%$ / Individual maximum 0,6%	$\leq 0,06\%$ Average value and individual maximum
	Classification	Definition § 3.2 and § 3.7	BI _s - Porcelain tiles
			Physical properties
	Modulus of rupture - (ISO 10545-4)	Average ≥ 35 N/mm ²	≥ 35 N/mm ²
	Breaking strength - (ISO 10545-4)	Average ≥ 1300 N for thickness $\geq 7,5$ mm Average ≥ 700 N for thickness $< 7,5$ mm	Complies
	Resistance to deep abrasion - (ISO 10545-6)	Max volume abraded ≤ 175 /mm ³	< 175 /mm ³
	Resistance to surface abrasion - (ISO 10545-7)	Abrasion class and cycles passed	Class 0 - 5
	Recommended use	Novabell criterion	Class 4 (see Annex N - ISO 13006 / EN 14411)
	Coefficient of linear thermal expansion - (ISO 10545-8)	Declared value ⁽¹⁾ / Test method available ⁽²⁾	$< 7,1 \times 10^{-6}$ °C ⁻¹
	Thermal shock resistance - (ISO 10545-9)	Pass according to EN ISO 10545-1 ⁽¹⁾ / Test method available ⁽²⁾	Complies
	Crazing resistance - (ISO 10545-11)	Pass according to EN ISO 10545-1 ⁽¹⁾ / Required ⁽²⁾	Complies
	Frost resistance - (ISO 10545-12)	Pass according to EN ISO 10545-1 ⁽¹⁾ / Required ⁽²⁾	Complies
	Moisture expansion - (ISO 10545-10)	Declared value ⁽¹⁾ / Test method available ⁽²⁾	$\leq 0,2$ mm/m
	Small colour differences - (ISO 10545-16)	$\Delta E_{cmc} < 0,75$ ⁽¹⁾	If agreed
	Impact resistance - (ISO 10545-5)	Declared value ⁽¹⁾ / Test method available ⁽²⁾	COR $> 0,75$
	Reaction to fire	Class A1 or A1 _{FL} ⁽¹⁾	A1 _{FL} (Classified Without Testing (CWT) - GB4033 EC)
	Mohs hardness scale - (ex EN 101 / BS 6431-13)	-	≥ 5
			Chemical properties
	Chemical resistance - (GL) (ISO 10545-13): • Resistance to low and high concentrations of acids and alkalis • Resistance to household chemicals and swimming pool salts	Declared value ⁽¹⁾ / Manufacturer is to state classification ⁽²⁾ Minimum class B	Resistant (see "Maintenance and care" section) A
	Resistance to staining - (ISO 10545-14)	Minimum class 3	5 (see "Maintenance and care" section)
	Release of dangerous substances - (ISO 10545-15)	Declared value ⁽¹⁾ / Test method available ⁽²⁾	Pb $< 0,1$ / Cd $< 0,01$ mg/dm ²
			Dimensions and surface quality
	Dimensions - (ISO 10545-2)	See ANNEX G	Complies
	Surface quality - (ISO 10545-2 § 7)	A minimum of 95% of the tiles shall be free from visible defects that would impair the appearance of a major area of tiles	Complies
			Slipperiness
	Determination of anti-slip properties - Workrooms and fields of activities with raised slip danger, walking method- Ramp test (DIN 51130) - Germany	BGR / ASR	From R9 to R13 R10
	Determination of anti-slip properties, Wet-loaded barefoot areas - Walking method - Ramp test (DIN 51097) - Germany	GUV-I 8527	A-B-C A + B
	Dynamic Coefficient Friction wet and dry condition (BCR - ex BCRA) Italy	DM n. 236 / 1989	$\mu > 0,40$ $\mu > 0,40$

(1) Requirements according to EN 14411 (2) Requirements according to ISO 13006

 La tabella in italiano con i dati tecnici è scaricabile su www.novabell.it

 The English language technical specification for each collection can be downloaded from www.novabell.it

 Si vous le souhaitez, téléchargez le tableau contenant les données techniques en français en allant sur www.novabell.it

 Die Tabelle in deutscher Sprache kann auf www.novabell.it heruntergeladen werden.

IMBALLI e PESI / Packaging and weights / Verpackungen und Gewichte / Emballages et poids

	SCATOLA / BOX			PALLET			
	pz	m2	kg	box	m2	kg	≡
60x120	2	1,440	30,0 	32	46,080	960	9,5
60x90	2	1,080	22,0	44	47,52	968	9,5
60x60	3	1,080	22,5	40	43,200	900	9,5
30x60	7	1,260	25,9 	40	50,400	1036	9,5
19,5x58,5 Losanga	6	0,685	9,3	36	24,660	335	9,5
60x90	1	0,540	23,6	44	23,760	1038	20
Modulo 3 Formati	1 cp.	1,620	71,7 	14 cp.	22,680	1004	20

MERCHANDISING



PG ALK FT



PG ALK FT 60x120



PG ALK FT 60x60



SCAALK6



PG ALK F1



SCA-ALK

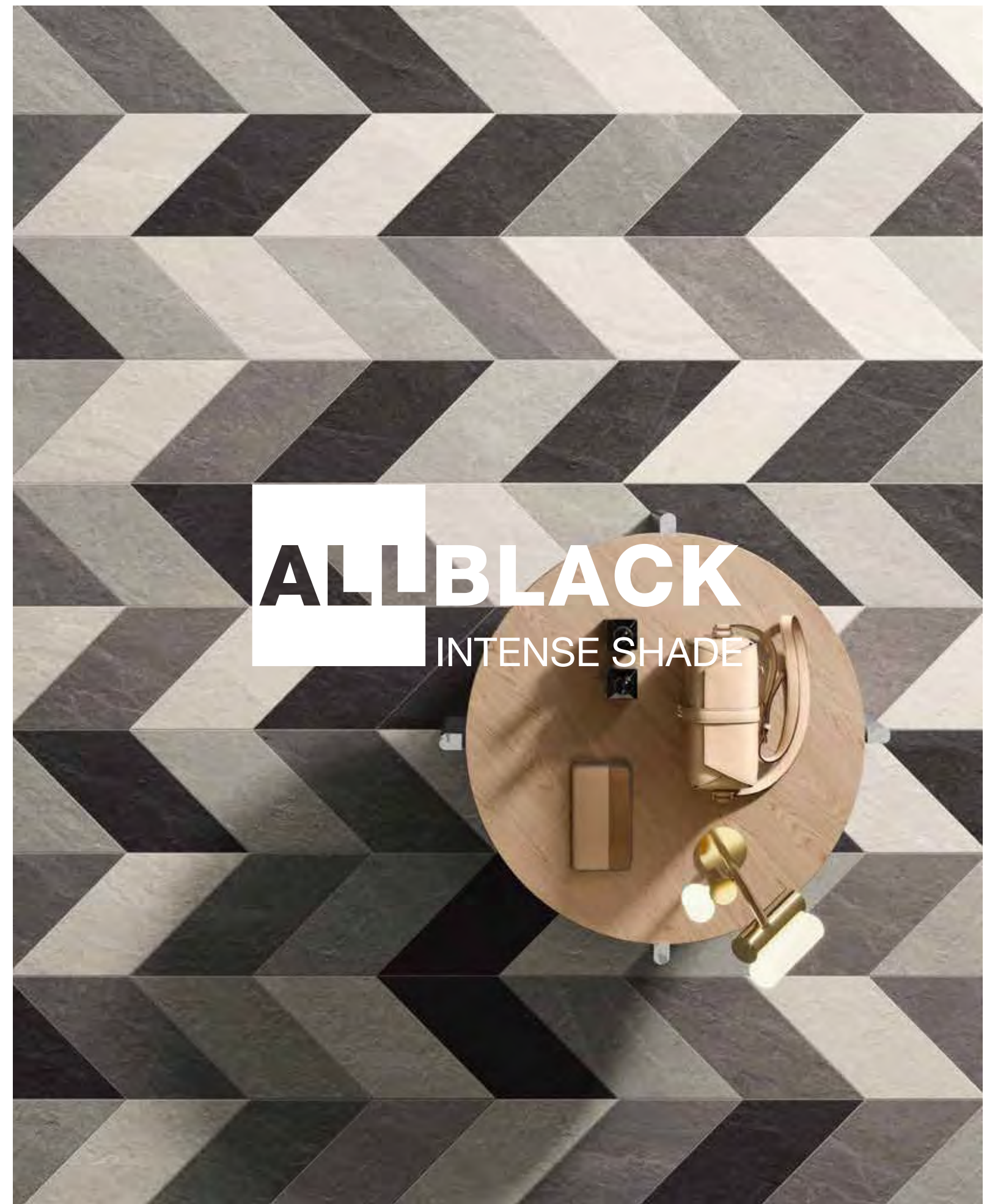

CAT-ALK



575 Broadhollow Road, Farmingdale, NY
11735
Phone 631.293.8453
Fax 631.753.6277
info@nashstonegroup.com

